

OPERATING INSTRUCTIONS



Quality Tools for Smart Cleaning

ENGLISH

HYDRO POWER RO SYSTEM



**READ THE OPERATING
INSTRUCTIONS BEFORE SWITCHING
ON THE SYSTEM!**

**KEEP IT IN THE IMMEDIATE VICINITY
OF THE MACHINE AT ALL TIMES!**

Original operating instructions
Revision Status: Version 1.2

Unger Germany GmbH

Piepersberg 44 • 42653 Solingen • Germany

Tel.: +49 (0) 212 2207-0 • Fax: +49 (0) 212 2207-222

E-Mail: ungereurope@ungerglobal.com • www.ungerglobal.com

1	Introduction.....	4
1.1	General information.....	4
1.2	Intellectual and industrial property rights	4
1.3	Property and legal deficiencies	4
1.4	Explanation of signs.....	5
1.4.1	Instructions for use	5
1.4.2	Enumerations	5
1.4.3	Hazard classes	6
1.4.4	Warning signs.....	7
1.4.5	Mandatory signs	7
1.5	Nameplate.....	8
1.6	Obligation of the operator.....	8
1.7	Obligation of personnel.....	8
1.7.1	Requirements for staff	8
1.7.2	Training of staff	9
1.8	Storing the operating instructions	9
1.9	Contact addresses	9
2	About HydroPower RO	10
2.1	Using the HydroPower RO	10
2.1.1	Intended use.....	10
2.1.2	Foreseeable misuse	10
2.2	Technical specifications.....	10
2.2.1	Operating conditions	10
2.2.2	Electrical specifications	10
2.2.3	Protection types of electrical components	10
2.2.4	Pressure ratings.....	11
2.2.5	Dimensions quick overview	11
2.2.6	Media connections	11
2.2.7	Water quality	11
2.2.8	Water output quantity.....	11
2.3	Scope of delivery	11
3	Safety	12
3.1	General safety regulations.....	12
3.1.1	Basic principles.....	12
3.1.2	Unit protection and warning processes	12
3.2	Mechanical hazards	13
3.3	Electrical hazards	13
3.4	Thermal hazards.....	13
3.5	Hazards due to pressure.....	13
3.6	Hazards from materials and substances	14

4	Preparing for use	15
4.1	Construction of the HydroPower RO.....	15
4.2	Interfaces	15
4.3	Transport and storage	16
4.3.1	Transportation	16
4.3.2	Storage	17
4.3.3	Operation the HydroPower RO.....	17
4.4	Commissioning	18
5	Operation of the HydroPower RO	20
5.1	General information.....	20
5.2	Controls, buttons and switches	21
5.3	The manometer	21
5.4	The settings menu	21
5.5	Cleaning surfaces with the HydroPower RO / Normal operation	23
5.6	Interruption of work.....	23
5.7	Switching off the HydroPower RO.....	24
5.8	Software update	25
6	Faults and messages.....	26
6.1	Procedure for accidents.....	26
6.2	Procedure for malfunctions.....	26
6.3	Troubleshooting	27
7	Maintenance and servicing	28
7.1	General information.....	28
7.2	Maintenance and maintenance plan	29
7.2.1	Daily inspection	29
7.2.2	Quarterly examination.....	29
7.2.3	Extraordinary maintenance.....	29
7.2.4	Membrane protection.....	30
7.3	Repair and replacement of parts.....	31
7.3.1	Replacing filter cartridges	31
8	Switching off the device.....	33
8.1	Disassembly and storage.....	33
8.2	Recycling.....	34
8.3	Disposal of waste	34
9	Evaluation options.....	35
9.1	Settings menu	35
10	Proofreading documents.....	36
10.1	EC Declaration of Conformity	36

1 Introduction

1.1 General information

This manual allows you to use the HydroPower RO safely and efficiently.

The operating instructions are part of the HydroPower RO and must be kept accessible to the personnel in the immediate vicinity of the HydroPower RO at all times.

Before starting work, the personnel must have read and understood this manual. All safety instructions and instructions for use stated in this manual must be followed for safe operation.

The current version of the HydroPower RO is described in this manual. If changes or additions become necessary over time, the operating instructions will be accompanied by a supplement which will be incorporated into the next revision.

The respective revision status of the operating instructions is displayed on the cover sheet. The first user manual has the revision status „1.0“. The status is increased by „1“ for each revision.

1.2 Intellectual and industrial property rights

All contents of this manual are the intellectual property of Unger Germany GmbH and are protected by copyright law.

The product, as well as the word / image mark, are legally protected.

Any duplication, processing, distribution or transfer to third parties - including, but not limited to - any kind of exploitation outside of the copyright limits require the written consent of Unger Germany GmbH.

In the case of infringements, Unger Germany GmbH reserves the right to take legal action at any time.

We reserve the right to make changes to this manual, as well as changes to technical details, with regard to the specifications and illustrations in this manual.

1.3 Property and legal deficiencies

Claims for material and legal deficiencies presuppose that the operator shall submit the defect in writing without delay, but at the latest within two working days.

Unger Germany GmbH is in no case responsible for damage to the system itself, or damage caused by the unit due to improper handling of the product.

In particular, Unger Germany GmbH is not responsible for failures or errors caused by modifications to the unit by the customer or other persons.

If Unger Germany GmbH is responsible for a defect, Unger Germany GmbH shall repair or replace the unit at its discretion.

Claims for material and legal deficiencies will be nullified in the case of non-compliance with the individual regulations of this manual, the relevant legal provisions, as well as further recommendations given by Unger Germany GmbH.

There are no claims to the availability of predecessor versions and to the retrofittings of delivered devices to the respectively current production level.

The equipment described in this manual contains data processing software developed by Unger Germany GmbH. In the corresponding descriptions this will be called „Software“ in this manual.

Unger Germany GmbH has protective rights to this software. In cases where these rights are owned by third parties, Unger Germany GmbH has the corresponding rights of use.

The software contains business secrets and copyrights.

No warranty will be given for software that has been modified, expanded or damaged, unless the change, modification, extension or damage was not the cause of the defect.

There is no further warranty obligation.

1.4 Explanation of signs

1.4.1 Instructions for use

Instructions for use are shown as follows:

To perform an action, proceed as follows:

1. Do this.
2. Do that.
- ▶ This is the intermediate result.
3. Do that.
- ✓ You have completed the action.

1.4.2 Enumerations

Enumerations are shown as follows:

- List of first order,
 - Second order,
 - Second order,
- List of first order.

Introduction

Explanation of signs

1.4.3 Hazard classes

Safety instructions are shown in this manual with standardized illustrations and symbols. Depending on the probability of the occurrence and severity of the consequence, the following hazard classes are used:



DANGER



Indicates a hazardous situation that can lead to serious injury or death.

- ▶ Here you will find measures to avoid the danger.



CAUTION



Indicates a potentially hazardous situation, which can lead to minor injuries.

- ▶ Here you will find measures to avoid the danger.

ATTENTION

Indicates a situation which can lead to material damage.

- ▶ Here you will find measures to prevent material damage.

NOTE



Here you can find application tips and other useful information.

1.4.4 Warning signs



Warning of a hazard.



Warning of electrical voltage.



Warning of overpressure in containers.



Warning of hot surfaces.



Warning of suspended loads.



Warning of injury to the limbs.

1.4.5 Mandatory signs



Application tips and other useful information.



Use protective gloves.



Use safety shoes.



Use protective goggles.

1.5 Nameplate

Each HydroPower RO from Unger Germany GmbH has a nameplate on the side.

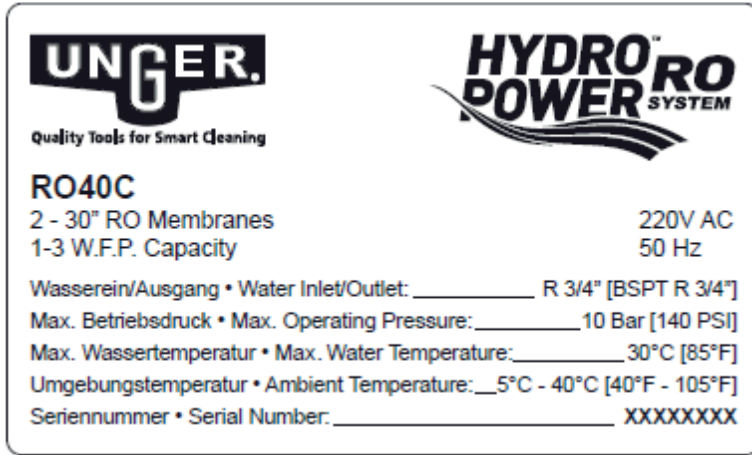

Pic. 1 Nameplate

1.6 Obligation of the operator

The HydroPower RO is used in the commercial sector. The operator must adhere to the statutory obligations to work safety.

The operator is obliged to have only persons working on the HydroPower RO that:

- are familiar with the basic regulations on work safety and accident prevention
- have been trained in the handling of the HydroPower RO
- have read and understood the safety instructions and safety regulations in this manual

The operator is obligated to ensure that all warnings on the HydroPower RO are always legible.

1.7 Obligation of personnel

Working with the HydroPower RO is only permitted if the operating instructions have been read and understood.

1.7.1 Requirements for staff

Only persons who perform their work reliably, should be authorized as personnel for this unit. Persons whose reactions and judgement are affected, e.g. by drugs, alcohol or medication, are NOT permitted to operate this unit.

NOTE



The operator is recommended to have this confirmed in writing.

Introduction

Storing the operating instructions



Quality Tools for Smart Cleaning

1.7.2 Training for staff

These operating instructions are aimed at staff with the following professional qualifications:

The staff will be able to carry out the tasks assigned to them and to recognize and avoid possible dangers independently on the basis of their professional training, experience and knowledge, as well as the knowledge of relevant provisions.

1.8 Storing the operating instructions

This instruction manual must be kept in the immediate vicinity of the HydroPower RO and must be available to the entire staff at all times. The operator must inform the personnel about the location of these operating instructions.

If the user manual has become illegible due to constant use, the operator must obtain replacement from the manufacturer.

These operating instructions can also be downloaded as a PDF at www.ungerglobal.com/downloads.

NOTE



When transferring or reselling the HydroPower RO to third parties, the following documents must be passed on to the new owner:

- ▶ this manual,
- ▶ the documentation of the repair work,
- ▶ proof of maintenance work.

1.9 Contact address

Unger Germany GmbH

Piepersberg 44
42653 Solingen
Germany

Telephone: (49) 0212 / 22 07-0

Fax: (49) 0212 / 22 07-2 22

service@ungerglobal.com

www.ungerglobal.com

2 About HydroPower R0

2.1 Using the HydroPower R0

2.1.1 Intended use

The HydroPower R0 is used for the filtration of drinking water by demineralisation for the purpose of glass and surface cleaning.

The HydroPower R0 is intended for commercial use only.

The HydroPower R0 may only be connected to drinking water lines.

2.1.2 Foreseeable misuse

The use of the HydroPower R0 in any way other than described in the chapter „2.1.1 Intended use“ is considered to be non-compliant and thus unlawful.

This applies in particular to the use of the HydroPower R0 for bacteria removal.

2.2 Technical specifications

2.2.1 Operating conditions

Ambient temperature [°C]	5 ... 40
Water temperature [°C]	5 ... 30

ATTENTION

Material damage due to improper handling.

Ensure that the incoming water corresponds to the national drinking water regulations.

The drinking water must be free of iron, manganese and heavy metals (max. 0.2 mg / l iron, 0.05 mg / l manganese), the maximum silicate (SiO₂) content must not exceed 20 mg / l. It must also not contain barium and strontium.

2.2.2 Electrical specifications

Primary electrical connection [V / Hz]	230 / 50
--	----------

2.2.3 Protection types of electrical components

Electric motor	IP 54
----------------	-------

About HydroPower RO

Scope of delivery



Quality Tools for Smart Cleaning

2.2.4 Pressure ratings

Input pressure [bar]	1 ... 6
Max. operating pressure [bar]	10

2.2.5 Dimensions quick overview

Height [mm]	1070
Width [mm]	530
Depth [mm]	700
Empty weight [kg]	75 kg

2.2.6 Media connections

Standard feedwater connection thread ["]	3/4
Standard concentrate connection thread ["]	3/4
Standard permeate connection thread ["]	3x 3/4
Data connection	USB 2.0, max. 8 GB

2.2.7 Water quality

Max. salt content in incoming water [ppm]	1000
SiO ₂ content in incoming water [mg/l]	20

2.2.8 Water output quantity

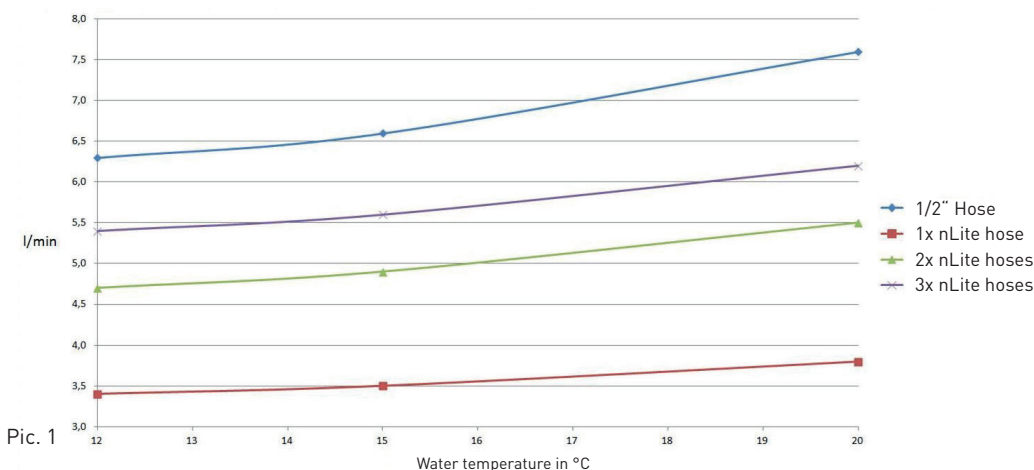

Pic. 1

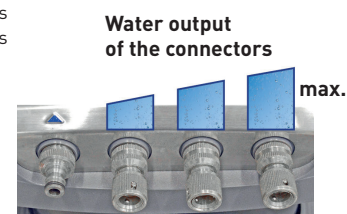

Pic. 1a

Pic. 1 Dependency of water temperature and hose diameter or number of hoses

Pic. 1a The right water connection receives more water from the membranes than the middle or the left. Therefore, long hoses or higher poles should be connected to the right connector.

2.3 Scope of delivery

The following is included in each delivery:

- HydroPower RO
- Concentrate hose
- Instruction manual
- Test report

3 Safety

3.1 General safety regulations

3.1.1 Basic principles

Special safety regulations may apply to certain activities. Safety instructions and warnings are given in the respective sections of the operating instructions.

Operate the HydroPower RO only:

- in accordance with the operating instructions for safety and driving safety
- if the HydroPower RO is in a technically sound condition.

This includes:

- The safety stickers attached to the HydroPower RO must always be complete and in good readable condition. Renew damaged or unreadable signs.
- Carry out cleaning and maintenance work on the HydroPower RO only if it is disconnected from electricity.
Turn off the main power switch and unplug the power cord.
- Carry out maintenance on the filter vessels only if they are depressurized.
- Clean the HydroPower RO after use of dirt and impurities.



Use personal protective equipment to avoid personal injury:

- ▶ protective gloves,
- ▶ safety shoes,
- ▶ safety goggles.



3.1.2 Unit protection and warning processes

Overheat protection

If the pump overheats, the overheat protection is triggered automatically and the HydroPower RO switches off.

Pressure relief valve

If the water pressure in the HydroPower RO is too high (above 10.5 bar), the pressure relief valve opens at the back of the HydroPower RO and releases excess water through the concentrate hose to reduce the pressure in the system.

3.2 Mechanical hazards



Crushing due to incorrect operation and / or carelessness.

- ▶ Do not reach between the ground surface and the HydroPower RO.
- ▶ Do not place objects in the openings of the HydroPower RO.



- ▶ Place the HydroPower RO on an even surface only.
- ▶ Ensure sufficient stability and secure the HydroPower RO against tipping over or rolling away.



- ▶ In the case of faults and emergencies, immediately turn off the unit by pressing the STOP button on the main switch of the HydroPower RO.
- ▶ Wear safety shoes.

3.3 Electrical hazards



Electric shock and burns due to live parts.

- ▶ Before each use, perform a visual inspection of the power cable for damage. If you notice any damage, contact your distributor.
- ▶ Maintenance on the electrical components of the system may only be carried out by employees of Unger Germany GmbH or their authorized specialist dealers / technicians.

3.4 Thermal hazards



Burns due to hot surfaces.

- ▶ The housing of the pump motor can become hot during operation. Allow the system to cool down sufficiently before touching components marked with this symbol.
- ▶ Wear protective gloves.



3.5 Hazards due to pressure



Injuries from pressurized containers.

- ▶ The 4 filter vessels are pressurized during operation.
- ▶ Never open a filter vessel during operation.
- ▶ Bleed the air out of the HydroPower RO before opening and during initialization by pushing the two yellow buttons on the lids of the front two vessels.

3.6 Hazards from materials and substances

The safety data sheets of the materials and substances can be found online at www.ungerglobal.com/downloads-safety-data-sheets.



Irritation to the eyes, skin and respiratory tract through carelessness.

- ▶ Avoid any contact with the resin when replacing the DI resin cartridge.
- ▶ In case of contact with eyes, remove contact lenses and rinse immediately with plenty of water.
- ▶ Wash hands after finishing work.
- ▶ Use protective gloves and goggles.



Irreversible injury due to slipping.

- ▶ If resin is spilled, carefully clean it up immediately as there is a high risk of slipping.
- ▶ Wear safety shoes.



Irritation to eyes, skin and respiratory tract through membrane care.

- ▶ Avoid any contact and swallowing of the membrane care liquid (sold separately).
- ▶ In case of contact with eyes, remove contact lenses and rinse immediately with plenty of water.
- ▶ Keep the membrane care liquid sealed and inaccessible to children.
- ▶ Use protective gloves and goggles.



Preparing for use

Construction of the HydroPower R0

4 Preparing for use

4.1 Construction of the HydroPower R0

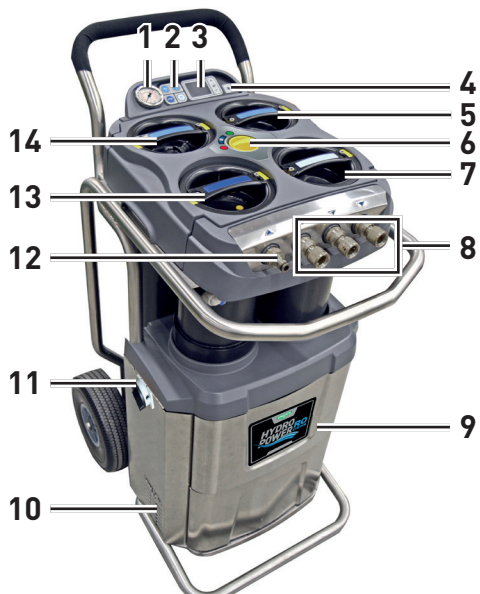

- 1 Manometer
- 2 Filter selection buttons
- 3 Display
- 4 STOP button
- 5 RO membrane 2
- 6 On/Off knob
- 7 DI resin filter
- 8 3 x water outlet
- 9 Front plate to reach the pump reset
- 10 Pump ventilation slot
- 11 Main switch (On / Off)
- 12 Water inlet
- 13 Carbon/sediment combi pre-filter
- 14 RO membrane 1

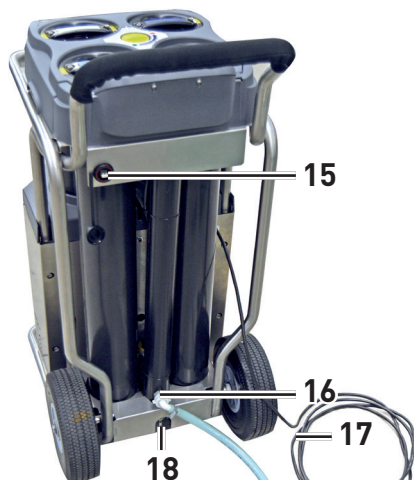

- 15 USB connector
- 16 Concentrate output
- 17 Power cord
- 18 Pressure valve (with lever for manual draining of water)

4.2 Interfaces



On the front are 3 connections for attaching hoses for water fed poles and 1 connection for the water supply. These are standard hose connections.

Make sure that water cannot flow back into the tap water line, e.g. through a backflow prevention device.

The water outlet for the concentrate is located at the back. Pour the concentrate down the drain using the enclosed concentrate hose.

At the rear there is also a USB port, which can be used to update the software, see chapter „5.8 Software update“.

4.3 Transport and storage

4.3.1 Transport

The HydroPower RO is delivered on a pallet by a forwarding company.

The HydroPower RO is carefully tested and packaged before shipment. However, damage during transport cannot be ruled out.

Therefore, immediately check the HydroPower RO for integrity in the presence of the dealer.

Check the completeness of the delivery, see chapter „2.3 Scope of delivery“.

Carry out a visual inspection of the HydroPower RO for transport damage.

If the HydroPower RO has been damaged during transport, show the damage to the company delivering HydroPower RO on behalf of your dealer.

Complaints due to transport damage cannot be accepted without written confirmation by the dealer or with unreserved acceptance!

In the case of transport of the HydroPower RO for use at height, e.g. on a house roof:



DANGER



Severe injuries and property damage due to the HydroPower RO falling are possible.



- ▶ Do not walk or grab under the suspended load.
- ▶ Use only the fixing points provided for fixing the hoist.
- ▶ Only use a suitable hoist.
- ▶ Secure the HydroPower RO to the transport.
- ▶ Observe the weight and maximum dimensions of the HydroPower RO.
- ▶ Wear protective gloves and safety shoes.



When transporting, ensure that the HydroPower RO is properly secured and cannot move in the transport. Protect the HydroPower RO from external damage.

Use the fixing points of the frame during transport, or if the HydroPower RO is lifted with a crane, in order to avoid damage.

4.3.2 Storage

If the unit is not in use for more than 7 days, the membranes must be protected according to the storage instructions, see chapter „7.2.4 Membrane protection“.

4.3.3 Operating the HydroPower RO

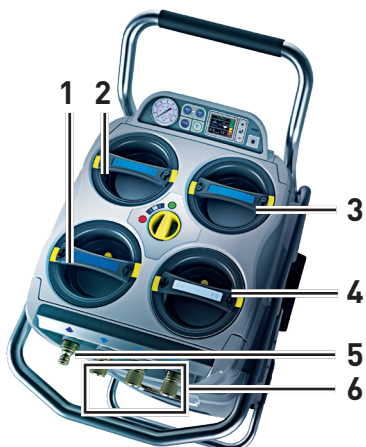

- 1 Carbon/sediment combi pre-filter
- 2 RO membrane 1
- 3 RO membrane 2
- 4 DI resin filter
- 5 Water inlet
- 6 3 x water outlet

Flow of water purification

The water enters the HydroPower RO via the water inlet (item 5).

The carbon/sediment combi pre-filter (item 1), which filters out the largest impurities and chlorine from the water and thus protects the membranes, sits before the membranes.

The 2 membrane filters (items 2, 3) remove up to 98% of the minerals from the water in the HydroPower RO.

The resin filter (item 4) sits after the membranes, which removes the last 2% of the minerals from the water in the HydroPower RO.

Pure water is discharged from the 3 water outlets (item 6) into a hose connected to a water fed pole for cleaning glass surfaces without chemicals.

The 4 filter cartridges (items 1 - 4) can be easily removed and replaced. The status and the current performance values can be checked via the display and pressing the corresponding buttons.

The measurement of the filter performance is set for maximum economic efficiency. If, for example, you fail to change the RO membrane, the resin in the resin filter will require frequent replacement, increasing your maintenance costs.

The measured values in the device are calculated for a consumption period of 12 months. As soon as the filter performance of the membrane decreases, the resin consumption increases slowly, since higher ppm values now arrive at the resin filter. If the exchange of the membranes is then more favorable than a continuous change of the resin cartridge, the device recommends a membrane change.

4.4 Commissioning



CAUTION



Slight injuries due to pressurized containers possible.



- ▶ The 4 filter vessels are pressurized during operation.
- ▶ Never open a filter vessel during operation.
- ▶ Check if the hoses and tubes are water-tight and fit properly before commissioning the system.
- ▶ Use protective gloves.

To start the HydroPower RO, proceed as follows:



1. Connect the power cord to the power supply.
2. Turn on the main power switch
 - ▶ The start screen appears.
 - ▶ A sequence of images appears in the display, which reminds you to connect the hoses and bleed the air out of the HydroPower RO.
3. Connect the hoses.
4. Turn on the water supply and make sure that the unit is completely filled with water. To check that, press the yellow pressure buttons. When water comes out, the vessels are filled.
5. Turn the on / off knob to the green position. The pump will turn on.
6. Bleed the HydroPower RO by pressing the button on the front two filters for a few seconds until water is discharged.

Preparing for use

Commissioning



Quality Tools for Smart Cleaning

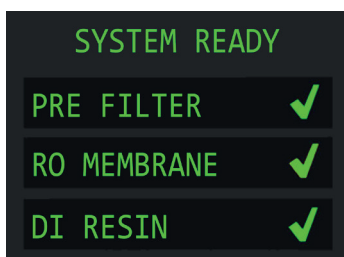
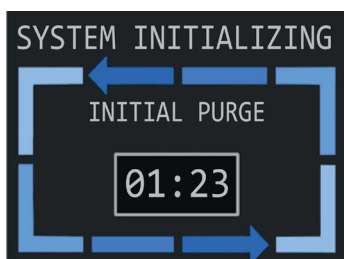

7. The system is automatically initialized. The resin is first by-passed. This is followed by a stabilization of the filters, in which a status measurement is carried out, so that all values are displayed correctly.

8. The display shows the status of the 4 filter cartridges. It uses a traffic light system.

- Green = Everything is all right.
- Yellow = The values reach a critical range, keep a replacement filter ready.
- Red = Caution, you should now change the filter.
- Red flashing of the selection buttons = Warning, change this filter right now. The filter is no longer effective and will cause the other filters to be used excessively and the cleaning performance is no longer guaranteed.

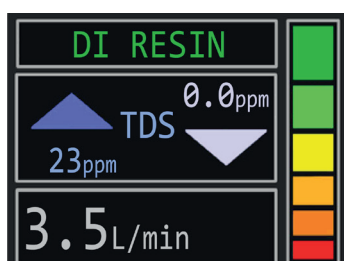

9. The display shows the overview of the resin filter, which informs you about the water quality being produced by the HydroPower RO.

- ▶ Use the buttons next to the display to switch between the filters.
- ▶ The state is indicated by the colours on the right side of the display.
- ▶ The colour in the display or the colour of the 4 buttons immediately indicates whether the filter is functioning properly or has to be replaced.

- The middle part of the display shows the TDS value (number of dissolved solids) of the incoming water (from the tap or from the previous filter) and the outgoing water (after filtering).

- The lower section shows the water flow.

- ▶ In the lower section of the carbon/sediment combi pre-filter display, the amount of water able to be filtered is counted down until the filter has to be replaced.

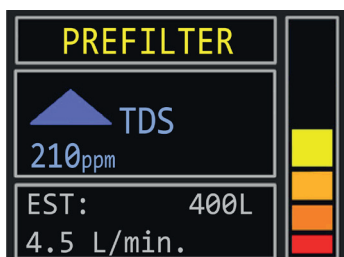

10. Turn the on / off knob back to the centre position.

- ✓ The HydroPower RO is now ready for use.



NOTE



You can adjust the amount of pure water produced by moving the on / off knob within the blue control range.

Centre position = Recommended working position for an optimal membrane life.

Below the centre position = less pure water is produced.

Above the centre position = more pure water is produced. The load on membranes and resin increases, which results in higher consumption costs.

5 Operation of the HydroPower R0

5.1 General information

Working with the HydroPower R0 is only permitted if the operating instructions have been read and understood.



DANGER



Severe injuries and property damage due to the HydroPower R0 falling are possible.



- ▶ Place the unit on a level surface only.
- ▶ Make sure the unit is stable and will not roll before operating the system.
- ▶ Wear safety shoes.



CAUTION



Slight injuries due to pressurized containers possible.



- ▶ The 4 filter vessels are pressurized during operation.
- ▶ Never open a filter vessel during operation.
- ▶ Check if the system is watertight before commissioning.
- ▶ Wear protective gloves.

Operation of the HydroPower R0

Controls, buttons and switches



Quality Tools for Smart Cleaning

5.2 Controls, buttons and switches



- 1 Manometer
- 2 Filter selection buttons
 - PRE: Carbon/sediment combi pre-filter
 - RO 1: RO membrane 1
 - RO 2: RO membrane 2
 - DI: DI resin filter
- 3 Display
- 4 STOP button
- 5 On / Off knob

The navigation in the setup menu is done with the arrow keys next to the display. The current selection is highlighted in yellow. You can confirm a value or a function with the ENTER key. Press the STOP button to exit the setting menu.

5.3 The manometer



The manometer shows the water pressure on the membranes when the pump is running.

Ensure that the water pressure is at least 1 bar. The optimum is 4 bar, maximum should not exceed 6 bar.

The pump increases the pressure by approx. 4 bar. Accordingly, the pressure in operation should not exceed 10 bar.

At a pressure of 10.5 bar, the pressure relief valve opens automatically at the rear.

5.4 The settings menu



To enter the settings menu, proceed as follows:

1. Stop the HydroPower R0 with the STOP button.
 2. Press the ENTER button to enter the settings menu.
- ✓ You can now view or change all settings.

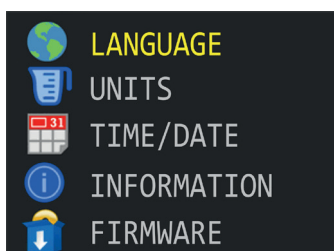

The main menu allows you to view or change various parameters such as units of measurement, time / date, information, software status etc.

Operation of the HydroPower R0

The settings menu



Select the top menu item to set the LANGUAGE:

- Press the ENTER button to select.
- The current selection is highlighted in yellow.

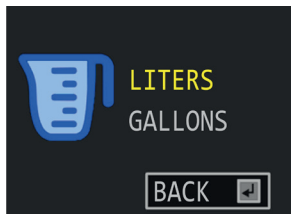

Select the menu item UNITS to set the unit of measure for water.

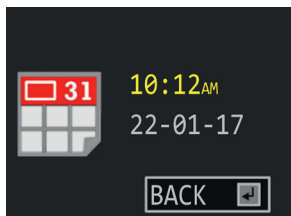

Select the menu item TIME / DATE to set the 12-hour or 24-hour time display.

This is for diagnostic purposes and should not be changed after correct initial adjustment. The values can be set with the arrow keys.

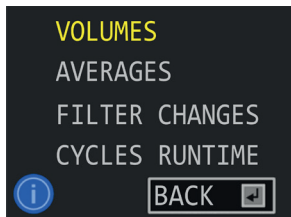

Select the menu item INFORMATION to find useful information about the performance of the HydroPower R0.

- VOLUME - water flow and water production,
- AVERAGES - average water values as well as average pure water quality after filtering through the membrane,
- FILTER CHANGES - frequency of the previous filter changes,
- CYCLE RUNTIME - information on the frequency of the system starts, resin bypasses and pump running time.

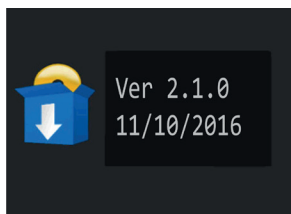

Select the menu item FIRMWARE to find the current version of the operating software. This can be updated via USB stick. See chapter „5.8 Software update“.

Operation of the HydroPower RO

Cleaning surfaces with the HydroPower RO



Quality Tools for Smart Cleaning

5.5 Cleaning surfaces with the HydroPower RO

The HydroPower RO has three water outlets so that 3 people can work in parallel.

The water pressure is distributed over the 3 outlets and depends on the hose length or hose diameter used.

We recommend regulating the water pressure between the 3 hoses, especially with height differences, with a valve. For example the UNGER hose connection # 18330 incl. water switch or the UNGER HiFloControl # TMOOV, regulate the water quantity at the water fed pole.

Water output
of the connectors

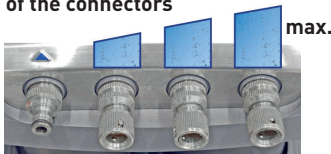

Note that the right water connection receives more water from the membranes than the middle or the left. Therefore, long hoses or higher poles should be connected to the right water output.

NOTE



The longer the hose from the water outlet to the water fed pole, the larger the diameter of the hose should be.

5.6 Interruption of work

If you need to interrupt your work with the HydroPower RO, proceed as follows:

1. Stop the HydroPower RO by pressing the STOP button.
Leave the on / off switch in the current position.
 2. To resume the work, turn the on / off knob to the green position and then to the centre position. If the on / off knob is already in the green position, slightly turn it to the left and then back to the green position.
- ✓ The HydroPower RO is restarted and ready for use immediately. The self-cleaning process is skipped when the HydroPower RO is restarted within an hour.

5.7 Switching off the HydroPower R0

When the HydroPower R0 is switched off, a self-cleaning process starts. For 1 minute, 100% of the incoming water flows with increased pressure through the RO membrane 1 and the RO membrane 2 and is discharged through the concentrate hose at the rear.

To switch off the HydroPower R0 after finishing the work, proceed as follows:

1. Turn the on / off switch to OFF.
 - ▶ The automatic self-cleaning process starts, which rinses the residues from the membrane. This operation lasts approx. 1 minute, do not interrupt it.
2. Three displays appear in an automatic sequence.
3. Switch off the main switch and disconnect the HydroPower R0 from the water supply and the power supply.
 - ✓ The HydroPower R0 is switched off and can be transported.

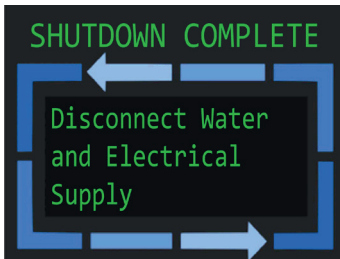
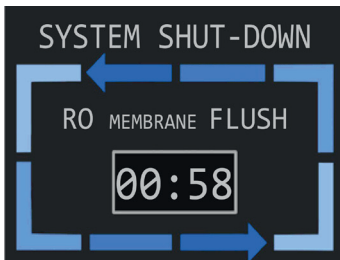

Operation of the HydroPower RO Software Update



Quality Tools for Smart Cleaning

5.8 Software Update

On the Unger website, system updates are offered as required. If you have registered there, you will automatically be informed about updates.

To perform the software update, proceed as follows:

1. Go to www.ungerglobal.com and select „Downloads“ in the menu and then „Software Updates“.
2. From System-Version 3.x a new graphic update (1.3) must be completed before the new system update is installed.
3. Download the system file (.pgm) and the prphic update (.bin). Use a USB 2.0 stick with maximum 8 GB. Please save the file directly, not in a folder. The file must be the only one on the stick, otherwise the update doesn't work! Start with the graphic update before you install the system update.
4. Make sure the HydroPower RO is switched off.
5. Plug the USB stick into the USB port on the back of the HydroPower RO.
6. Press and hold the ENTER button on the display while you turn the main switch on ...



1. Graphik-Update (.bin-file)

- See above steps 1-6, and proceed:
- After the first beep you can release the ENTER-button.
- Wait about 45 seconds until you hear a second beep. The display will turn on and the RO starts up automatically.
- During this period do not switch off the power or press any button!
- After the graphic update and startup, random images will appear in the display. This is normal. After the new software update the proper images will be displayed.
- Now delete the grphic file from the stick (or use a second stick) and copy the system file (.pgm) on it. Continue with the system update.

2. System-Update (.pgm-Datei)

- See above steps 1-6, and proceed:
- A brief beep will complete the operation after a few seconds and then you can release the ENTER button.
- The HydroPower RO starts normally, as after switching on.
- If the RO should not work properly after the update, please repeat the process again.

You can check the correct installation:

- Stop the system by pressing the STOP-button
- Press ENTER and select FIRMWARE in the display.
- Now the version and the release date is shown in the display.

6 Faults and messages

6.1 Procedure for accidents

Press the main switch located on the side of the HydroPower RO to turn off the system:

- In case of danger of injury,
- Risk of damage to the HydroPower RO.

In the event of an accident, take immediate action and call the local emergency number.

ATTENTION

Material damage due to improper handling possible.

- ▶ Press the main switch only in emergency situations to turn the unit off immediately. As this avoids the self-cleaning process, this can damage the membrane and shorten the lifetime if it is turned off this way frequently.

6.2 Procedure for malfunctions

The following warning messages may appear in the display during operation:



Water pressure too low

- ▶ The inlet pressure from the water line is too low to provide the desired filter performance. The pump switches off.
- ▶ Check whether the supply hose is bent or whether there is too little pressure coming from the tap.
- ▶ Once the problem is resolved, rotate the on / off knob to the red position and back to the green position to restart the system.

Overheating

Always ensure that the HydroPower RO is well ventilated and not too close to objects or walls that prevent air circulation.

1. If the pump motor overheats, the HydroPower RO switches off automatically.
2. Turn the on / off knob to the red position.
3. Switch off the main power switch.
4. Allow the HydroPower RO to cool down.
5. Loosen the 4 screws on the sides of the HydroPower RO and remove the front plate.
6. Press the large red button on the pump control.
 - ▶ The pump motor is reset.
7. Replace the front plate and tighten the 4 screws.

Turn on the main power switch and start the HydroPower RO with the on/off knob.

- ✓ The HydroPower RO starts again. If the system does not start, let the HydroPower RO cool down even further.

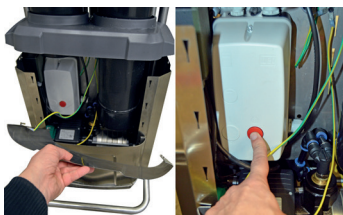

Overpressure

Overpressure can occur when the water pressure from the tap is more than 6 bar.

To check the water pressure of the line, proceed as follows:

1. Stop the HydroPower RO by pressing the STOP button.
 - ▶ The manometer indicates the line pressure.
 - ▶ As soon as the pump is switched on, the pressure increases by 4 bar. If the inlet pressure is too high, connect a valve to the water inlet or tap and regulate the water.
- ✓ The water pressure is checked and adjusted.



7 Maintenance and servicing

7.1 General information



DANGER



Electric shock possible through live parts.

- ▶ Maintenance on the electrical components of the system should only be carried out by employees of Unger Germany GmbH or their authorized specialist dealers / technicians.



CAUTION



Burns due to hot surfaces possible.

- ▶ The housing of the pump motor can become hot during operation. Allow the system to cool down sufficiently before touching components marked with this symbol.



- ▶ Wear protective gloves.

ATTENTION

Damage caused by improper cleaning of the HydroPower RO possible.

- ▶ Do not use aggressive cleaning agents and / or solvents.
- ▶ Observe the safety instructions for the cleaning and solvent of the respective manufacturer.

ATTENTION

Material damage due to insufficient maintenance possible.

- ▶ Before each use, perform a visual inspection of the power cord for damage. If you notice any damage, contact your distributor.

Membrane protection during storage

If the unit will not be in use for more than 7 days, the membrane must be protected according to the storage instructions, see chapter „7.2.4 Membrane protection.“

If the membrane is not regularly flushed or protected with the UNGER membrane care agent, there is a risk of blockage and thus a strong performance limitation or damage.

Frost protection

Never store the HydroPower RO below 5°C. When not in use for a longer period of time, drain the water from the HydroPower RO. Open the pressure relief valve on the back of the HydroPower RO until no water leaks out.

7.2 Maintenance and maintenance plan

The HydroPower RO has its own monitoring system and informs the user about the operating state and performance of the 4 filters by means of the display. It also warns of problems or status of each filter.

7.2.1 Daily inspection

Observe the indications on the display and the light signals on the 4 selection buttons next to the display and if necessary, follow the instructions being shown by the system.

- Green = Everything is all right.
- Yellow = The values come within a critical range, provide a replacement filter.
- Red = Caution, you should now change the filter.
- Red flashing of the selection buttons = Warning, change this filter right now. The filter is no longer effective and will cause the other filters to be used excessively, and the cleaning performance is no longer guaranteed.

7.2.2 Quarterly examination

- Grease the o-rings in each of the four top caps with a non-silicone-based grease.
- Lubricate the water connections with lubricant or oil, such as WD 40.

7.2.3 Extraordinary maintenance

The software of the HydroPower RO can be updated. You can download the latest version from the Unger website.

Save the file to a USB flash drive. The exact update process can be found in chapter „5.8 Software update“.

In order to regularly receive information about updates and other news, we recommend registering on the Unger website www.ungerglobal.com/register.

7.2.4 Membrane protection



CAUTION



Irritation to eyes, skin and respiratory tract through membrane care possible.



- ▶ Avoid any contact and swallowing of the membrane care fluid.
- ▶ In case of contact with eyes, remove contact lenses and rinse immediately with plenty of water.
- ▶ Keep the membrane care product sealed and inaccessible to children.
- ▶ Wear protective gloves and goggles.



The membrane achieves its optimal life with regular water flow or flushing.

If the HydroPower RO is not in use for an extended period of time (longer than 7 days), the membrane must be protected against blockage.

For this purpose, there is the UNGER Membrane Care Agent (Order No. 15436). You need one bottle (1l) for each membrane. This preserves the current state of the membrane and prevents reduced performance and/or damage after sitting for a longer period of time. Alternatively, you can run the unit once a week for approx. 30 minutes to rinse the membranes.

To protect the membrane, proceed as follows:

1. Switch off the HydroPower RO and disconnect the power supply.
 2. Drain the water from the HydroPower RO. Unscrew all filter top caps and open the pressure relief valve on the back of the HydroPower RO until no more water leaks out.
 3. Close the pressure relief valve and screw the yellow cap onto the concentrate outlet.
 4. Remove the pre-filter and resin filter cartridges and store them protected from dust and dirt.
 5. Pour one bottle of membrane care liquid (1l) into each of the membrane tanks.
 6. Fill all tanks (#1 pre-filter + both membranes #2, #3) with tap water until all three tanks have filled just below the top edge. Tank #4 can remain without water.
 7. Close all four tanks.
- ✓ The membranes are protected and the HydroPower RO can be stored.



Re-commissioning

1. Unscrew all 4 filter top caps.
2. Drain the water: Unscrew the yellow cap and assemble the concentrate hose. Now open the pressure relief valve at the rear.
3. Insert the filters. Pay attention to the correct position (see page 33).
4. Screw the top-caps back on and start the system.
5. The membrane care liquid is automatically rinsed out and the resin filter is protected by the by-pass process.

7.3 Repair and replacement of parts

You will find a spare part list on the Unger website www.ungerglobal.com/RO with parts that you can change yourself.

For any further repairs, please contact your dealer.

7.3.1 Replacing filter cartridges



CAUTION



Irritation to the eyes, skin and respiratory tract possible.



- ▶ In the filter cartridges, there is resin for the final demineralization of the water.
- ▶ Avoid any contact with the resin when working on the filter cartridges.
- ▶ Wear protective gloves and goggles.
- ▶ In case of contact with eyes, remove contact lenses and rinse immediately with plenty of water.
- ▶ Wash hands after finishing work.

If the display or the selection buttons show „red“, the corresponding filter cartridge must be changed.

Changing of all 4 filter cartridges is easy and fast.

To replace the filter cartridges, proceed as follows:

1. Switch off the HydroPower RO and disconnect the power supply.
2. Drain the water from the HydroPower RO.
Open the pressure relief valve on the back of the HydroPower RO until no water leaks out.
3. Press the two push buttons on the front two filters.
4. Rotate the filter cartridge top cap counter - clockwise.



Maintenance and servicing

Repair and replacement of parts



DI (#4)



5. Pull out the filter cartridge.
 6. Insert a new filter cartridge into the HydroPower RO.
 - ▶ With the carbon/sediment combi pre-filter, the flow direction does not matter. After the change, the value must be reset in the menu item FILTER CHANGE, see chapter „9 Evaluation possibilities“.
 - ▶ The 2 RO membranes and the resin filter have a printed arrow.
 - ▶ For the RO membranes, the arrow must point upwards. The rubber seal of the membrane must always be at the top (see diagram on page 33)!
 - ▶ When changing the DI resin filter, the sealing cap must be changed. Remove the old sealing cap from the outlet, at the bottom of the tank and place a sealing cap on the outlet, in the bottom of the tank (see pictures). Press it down completely. Replace the resin filter and press it gently on the sealing cap. Pay attention for the right position of the filter (see manual page 33). The arrow must point downwards. You can also see the correct position on the blue caps. The side with the paper filter must be at the top (see diagram). Otherwise, no water can flow through and a backflow occurs.
 7. Replace the top cap and turn it clockwise.
 - ▶ The top cap locks with a „click“ and must stay in this position (see picture). Do not turn it further !
 8. Proceed the same for all other filter cartridges.
- ✓ The filter cartridges are replaced.

Enter the filter change in the system

Stop the system with the STOP button and press one of the 4 filter buttons next to the display. Confirm CHANGE with the ENTER key in the display.



CHANGE = You confirm the current filter change.

In the **carbon/sediment pre-filter (PRE)**, the displayed liters are counted down, accompanied by the colour system. At 0, the carbon/sediment pre-filter has no more effect and must be replaced in order to preserve the membrane.

After the change, the counter must be reset with this function to display the current performance of the new filter.

Proceed equally with the other 3 filters. Thus the internal statistics always provide transparency for proper maintenance.

The RESET function is only for trained service personnel and should not be selected since the total statistic is set to 0 for this filter.

NOTE



The covers are marked with different shades of blue. The dark blue belongs to the front left vessel for the carbon/sediment combi pre-filter, the medium blue to the rear vessels for the membranes and the light blue to the front right vessel for the resin filter.

Switching off the device

Disassembly and storage

Water flow chart

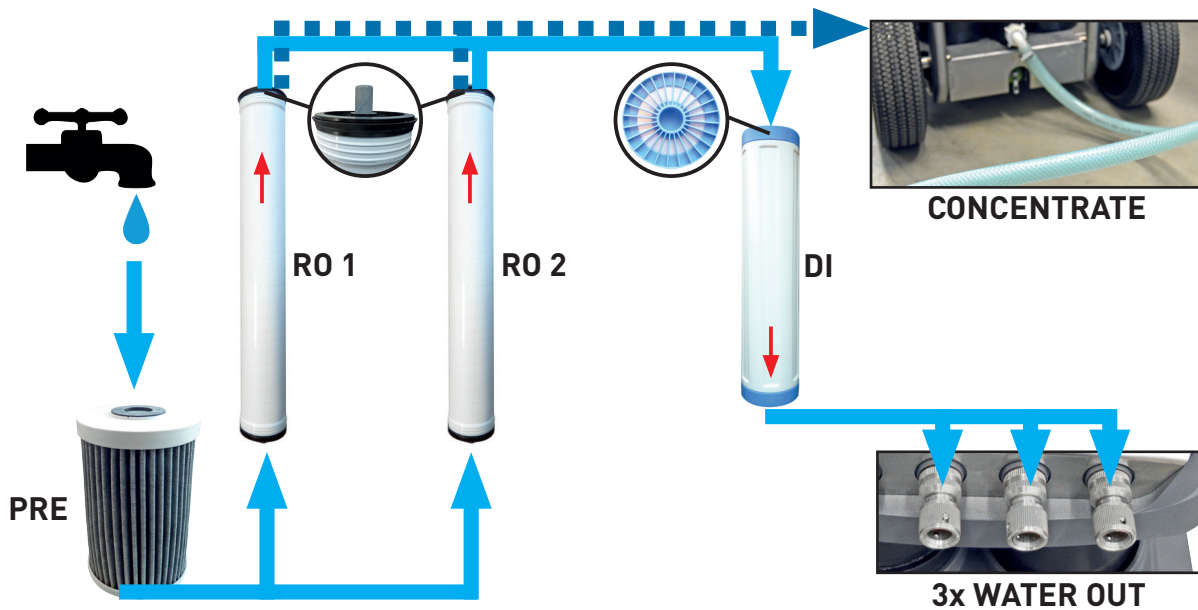

8 Switching off the device

8.1 Disassembly and storage



DANGER



Electric shock and burns due to live parts possible.

- ▶ Maintenance on the electrical components of the system may only be carried out by employees of Unger Germany GmbH or their authorized specialist dealers / technicians.



CAUTION



Burns due to hot surfaces possible.

- ▶ The housing of the pump motor can become hot during operation. Allow the system to cool down sufficiently before touching components marked with this symbol.
- ▶ Wear protective gloves.



ATTENTION

Material damage due to improper storage.

- ▶ Clean the system from dirt build up.
- ▶ Use only membrane care products from Unger Germany GmbH.
- ▶ Never store the HydroPower RO below 5°C.

NOTE



When storing for an extended period of time (e.g. winter, holidays), leave the filters in the HydroPower RO, where they are optimally protected against weathering.

To prepare the HydroPower RO for storage, proceed as follows:

1. Switch off the HydroPower RO and disconnect the power supply.
 2. Open the pressure relief valve on the back of the HydroPower RO and drain the water.
 3. Protect the membrane with membrane care liquid, see chapter „7.2.4 Membrane protection“.
- ✓ The HydroPower RO is prepared for storage.

8.2 Recycling

Properly recycle all materials that can be recycled to help protect our environment.

The packaging material is to be separated. It consists of foam, wood, plastic and corrugate cardboard and is to be recycled individually according to recycling standards.

8.3 Disposal of waste

If the HydroPower RO has reached the end of its life cycle, it must be disposed safely and professionally, particularly with regard to parts or substances harmful to the environment.

Before disposing of the HydroPower RO, remove all 4 filter cartridges and dispose of them in accordance with the national regulations at your disposal company.

In order to avoid danger to the environment, an approved specialist company is to be commissioned to dispose of the filter cartridges. The local authority can provide information on this.

Return the HydroPower RO for disposal to Unger Germany GmbH.

9 Evaluation options

9.1 Settings menus

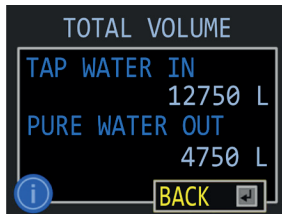

TOTAL VOLUME	
TAP WATER IN	12750 L
PURE WATER OUT	4750 L

BACK

Under the menu item TOTAL VOLUME, you can see how much water has already been fed into the HydroPower RO and how much water has been produced so far.

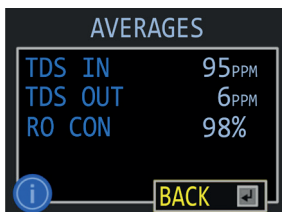

AVERAGES	
TDS IN	95 ^{PPM}
TDS OUT	6 ^{PPM}
RO CON	98%

BACK

Under the menu item AVERAGES you will find the average concentration of the water at the water inlet and outlet. It also indicates the average efficiency of the RO membranes.

This gives you an overview of the water quality in the region in which you work.

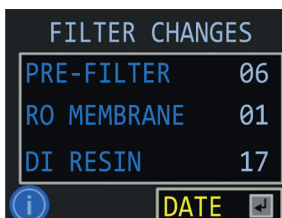

FILTER CHANGES	
PRE-FILTER	06
RO MEMBRANE	01
DI RESIN	17

DATE

Under the menu item FILTER CHANGES you will find the statistical values of how often and when the last time each filter has been changed. The system automatically detects resin filters and membrane filters.

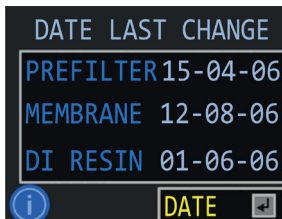

DATE LAST CHANGE	
PREFILTER	15-04-06
MEMBRANE	12-08-06
DI RESIN	01-06-06

DATE

Under the menu item CYCLES/RUNTIME, you will find out how many times the system has been flushed (when switched off), how many times the resin filter has been by passed, and the pump running time (in hours).

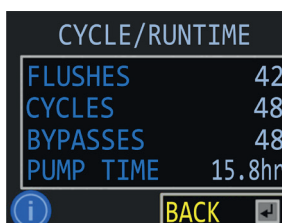

CYCLE/RUNTIME	
FLUSHES	42
CYCLES	48
BYPASSES	48
PUMP TIME	15.8hr

BACK

10 Verification document

10.1 EC-Declaration of Conformity

The R040C is compliant with the provisions of the Machinery Directive 2006/42 / EC and the Directive on Electromagnetic Compatibility 2014/30 / EU.

The protection objectives of Directive 2014/35 / EU on electrical equipment have been upheld.

Applied harmonized standards:

EN ISO 12100:2011 Security of machines -
 General design principles - risk assessment
 and risk reduction

EN 60204-1:2010 Electrical equipment of machines -
 General requirements

This is confirmed by the EC Declaration of Conformity.

Solingen, 03.04.2017



Managing Director
Unger Germany GmbH



NOTE



The system is only intended for professional use and operation at 230 V / 50 Hz in an industrial low-voltage network.

Unger Germany GmbH
Piepersberg 44
D-42653 Solingen
GERMANY
Tel.: (49) 0212 / 22 07-0
Fax: (49) 0212 / 22 07-222
ungereurope@ungerglobal.com

Unger UK Ltd.
9 Planetary Ind. Est.
Willenhall, WV13 3XA
United Kingdom
Tel.: (44) 01902 306 633
Fax: (44) 01902 306 644
ungeruk@ungerglobal.com

Unger Enterprises LLC
425 Asylum Street
Bridgeport, CT 06610
USA
Tel.: (1) 800.431.2324
Fax: (1) 800.367.1988
unger@ungerglobal.com